



■ Vers. 225+281+010+489+100



■ Vers. 223+281+010+281



■ Vers. 010+312+312



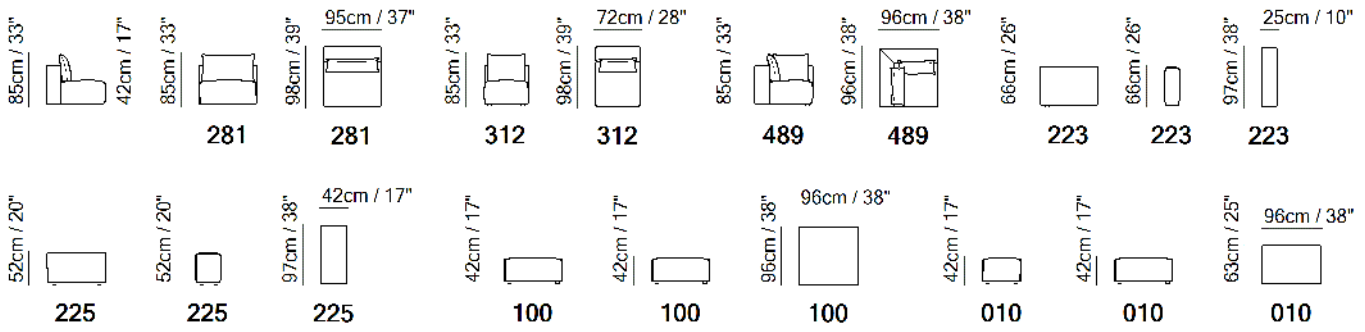

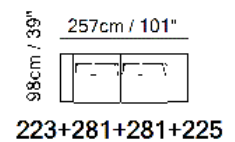
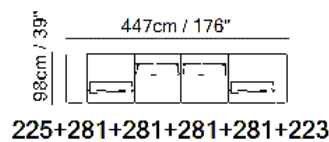
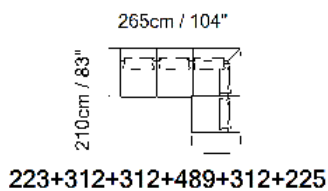
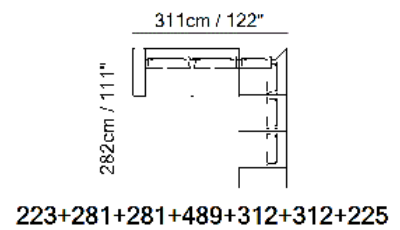
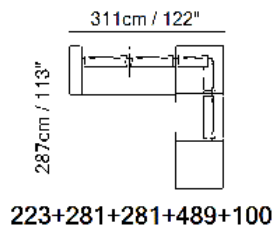
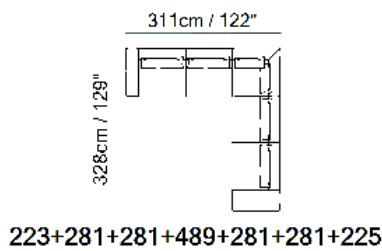

SCHEMATICS



COMPOSITION EXAMPLES



TECHNICAL INFORMATION

	COVERING	Soft Cover <input checked="" type="checkbox"/>					
	OPTIONS	Removable <input type="checkbox"/>	Contrast Stitching <input type="checkbox"/>				
	FILLING	Arms <input type="checkbox"/> Fiber <input type="checkbox"/> Foam <input type="checkbox"/> Feather/Fiber Mix <input type="checkbox"/> Feather	Seat cushion <input type="checkbox"/> Fiber <input type="checkbox"/> Foam <input type="checkbox"/> Feather/Fiber Mix <input type="checkbox"/> Feather	Back cushion <input type="checkbox"/> Fiber <input type="checkbox"/> Foam <input type="checkbox"/> Feather/Fiber Mix <input type="checkbox"/> Feather			
	COMFORT	Standard Comfort <input checked="" type="checkbox"/>	Firm Comfort <input type="checkbox"/>				
	FUNCTION	Bed <input type="checkbox"/>	Electric motion <input type="checkbox"/>	Motion <input type="checkbox"/>	Recliner <input type="checkbox"/>	Sliding <input type="checkbox"/>	
	LEGS	Metal <input type="checkbox"/>	Wood <input type="checkbox"/>	Plastic <input type="checkbox"/>	Castors <input type="checkbox"/>	Upholstered <input type="checkbox"/>	

NOTES

- To allow modularity, the single elements can be put together thanks to the rubber stops under the legs.
- Model Puzzle with its two size module seats (versione 312 or 281) is particularly suitable for "reverse seating" sectional configurations. Seat versions (312, 281) and corner (489) come with loose back cushions in same cover as the rest of the element (the loose back cushion is not orderable seperately).
- 2 arms with different dimensions (233 with slim/high arm or vers 225 with large/low arm). The single arm can be used both on left or right side of your sectional throughout a universal connector.
- 2 size ottomans (versions 010 or 100) that can both be used as a terminal elmeent or in the middle of the seats of your sectional.

NOTES
